

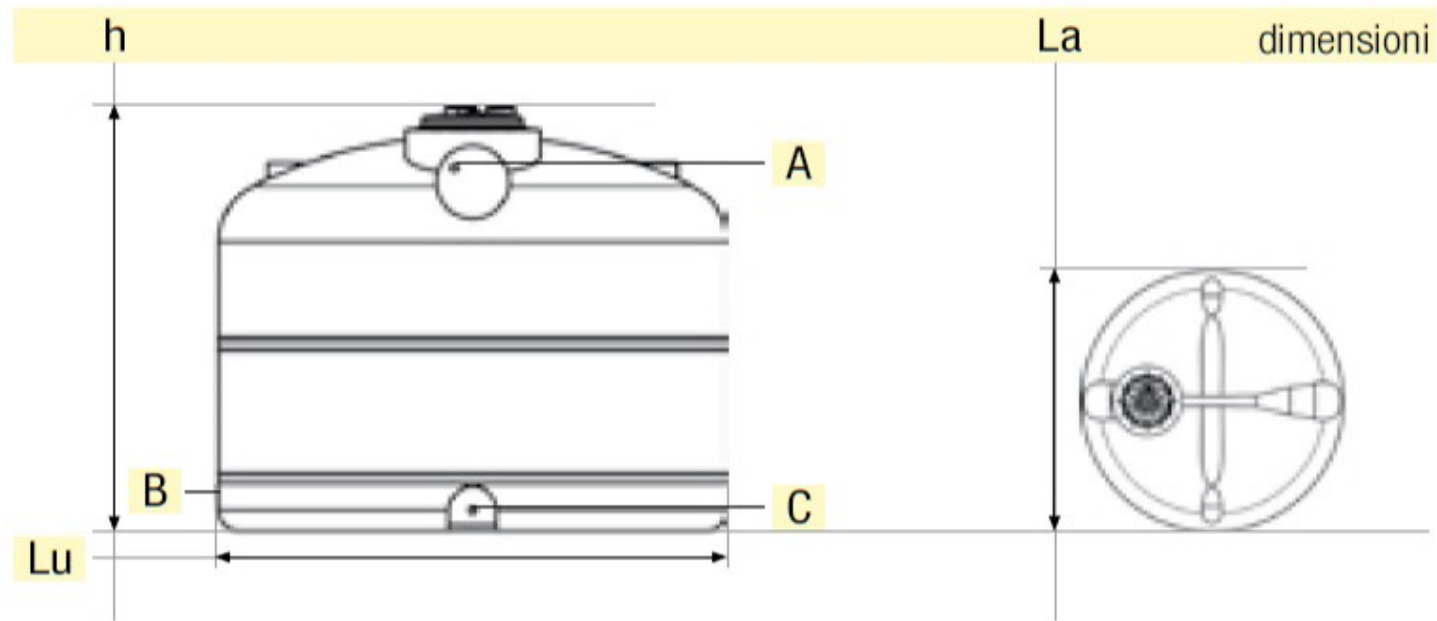

PLASTICA CESENA Srl
Via prati 2025
47034 FORLIMPOPOLI (FC)
Tel.0543 745063 - 342 1560163
Fax.0543 744632
<http://www.plasticacesena.com>
e-mail:info@plasticacesena.com
Iscr. R.E.A. Forli N:183969
Reg. imprese Forli-Cesena
P.I./C.F. 01219560404
Cap. Soc. € 46.530,00 int. vers



codice	volume lit	diametro x altezza cm	Ø Tappo cm
STEPA080	8.000	Ø245x201	1x40